

RoHS  Lead-free

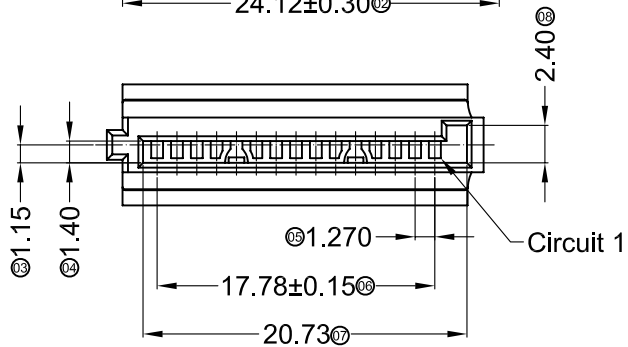

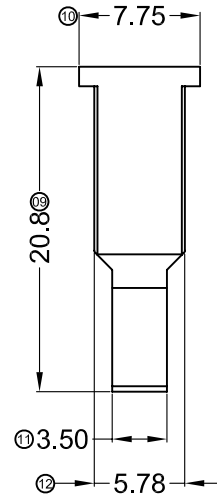
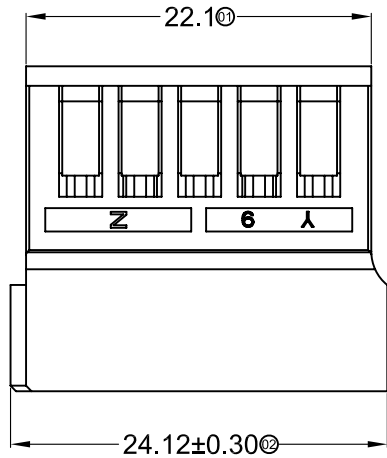
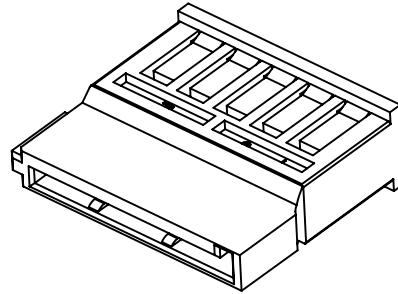
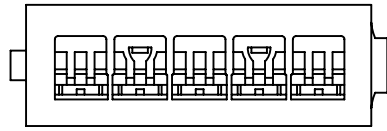

■ Specifications :

- Voltage rating: 15V AC / DC
- Current rating: 1.5A AC / DC
- Withstanding voltage: 500V AC/minute
- Temperature range: -35°C~+85°C
- Insulation resistance: ≥1000MΩ
- Contact resistance: ≤30mΩ
- After environmental testing: ≤60mΩ

1272 H X-15 X-XX HF
 ① ② ③ ④ ⑤ ⑥ ⑦

- ① Series No.
- ② Category: H-HSG
- ③ Welding Board Angle: Blank-ordinary
- ④ Row No.-Pin No.: 15-15P
- ⑤ Plug the Pin & special No.:
- ⑥ Material: N0-PA66 94V-0; PT-PBT UL 94V-0
- ⑦ HF-Halogen free

1272H-15-N0HF	PA 66 UL 94V-0 Halogen-Free	1272T
1272H-15-PT	PBT UL 94V-0	
PART NO.	Material	Suitable SWB Terminal

							GENERAL TOLERANCE	 思索连接器有限公司 SWB CONNECTORS CO.,LTD				PART NO. 1272H-15-XXXX			
							.X ±0.30					TITLE 1.27mm Crimp Style Connectors			
14/06/16	A	B	Space of a Whole page Changes	Jova Lau	Jova Lau	PROJECT		APPROVAL	CHECK	DRAWN	DATA	UNIT	SCALE	NUMBER	REV
DATE	OLD REV	NEW REV		ECN	DESCRIPTION	CHECK	APPROVAL		Jova Lau	Jova Lau	Wuxiaotao	2013/08/26	MM	1:1	A-022

RoHS  Lead-free

■ Specifications :

- Voltage rating: 15V AC / DC
- Current rating: 1.5A AC / DC
- Withstanding voltage: 500V AC/minute
- Temperature range: -35°C~+85°C
- Insulation resistance: ≥1000MΩ
- Contact resistance: ≤30mΩ
- After environmental testing: ≤60mΩ

1272 HI -15 XXX-PT XX

① ② ③ ④ ⑤ ⑥ ⑦

- ① Series No.
- ② Category: H- HSG
- ③ Welding Board Angle:
I- HSG Plus hardware assembly products
- ④ Row No.-Pin No.: 15-15P
- ⑤ Plug the Pin & special No.:
V18- AWG#18 With 180° CAP
V20- AWG#20 With 180° CAP
V22- AWG#22 With 180° CAP
R18- AWG#18 With 90° CAP
R20- AWG#20 With 90° CAP
R22- AWG#22 With 90° CAP
- ⑥ Material: PT- PBT UL 94V-0
- ⑦ Color: Blank- Natural Color

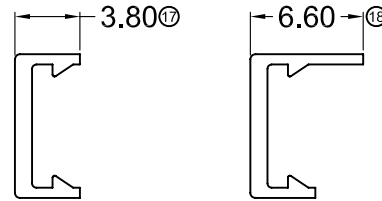
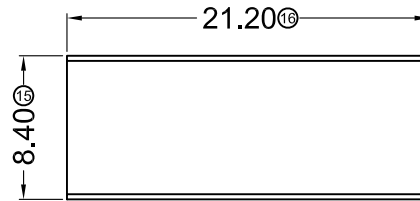
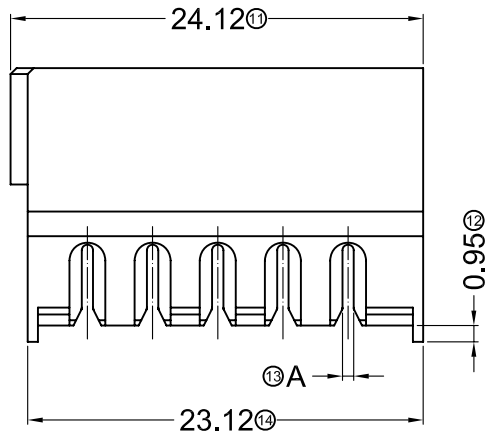
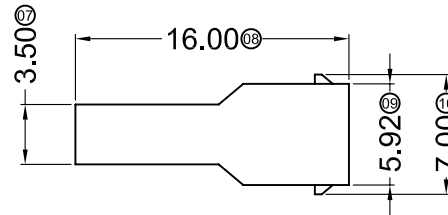
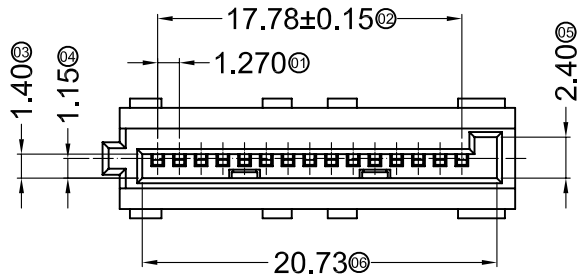
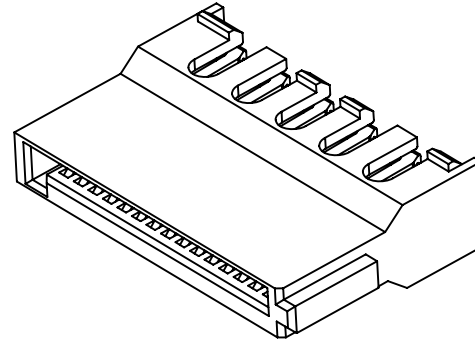
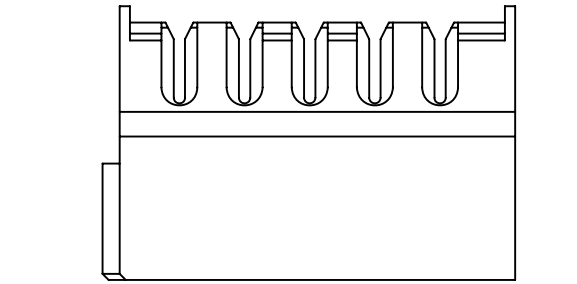

1272CV-PT

1272CR-PT

1272HI-15R22-PT	PBT UL 94V-0	Phorphos Bronze	Contact Area Gold	AWG#22,90° CAP	0.52
1272HI-15R20-PT				AWG#20,90° CAP	0.60
1272HI-15R18-PT				AWG#18,90° CAP	0.65
1272HI-15V22-PT				AWG#22,180° CAP	0.52
1272HI-15V20-PT				AWG#20,180° CAP	0.60
1272HI-15V18-PT				AWG#18,180° CAP	0.65
PART NO	Material	Material (Terminal)	Finish (Terminal)	Wire Range	A

				GENERAL TOLERANCE		SWB 思索连接器有限公司				PART NO. 1272HI-15XXX-PT			
				.X ±0.30		TERMINAL&CONNECTORS SWB CONNECTORS CO.,LTD				TITLE 1.27mm IDC Style Connectors			
				.XX ±0.20		APPROVAL	CHECK	DRAWN	DATA	UNIT	SCALE	NUMBER	REV
2014/06/10	B	C	Space of a Whole page Changes	Jova	Bob	Bob Sun	Jova Lau	Wuxiaotao	2014/06/11	MM	1:1	A-022	C
DATE	OLD REV	NEW REV	ECN	DESCRIPTION	CHECK	APPROVAL	PROJECT						

RoHS  Lead-free

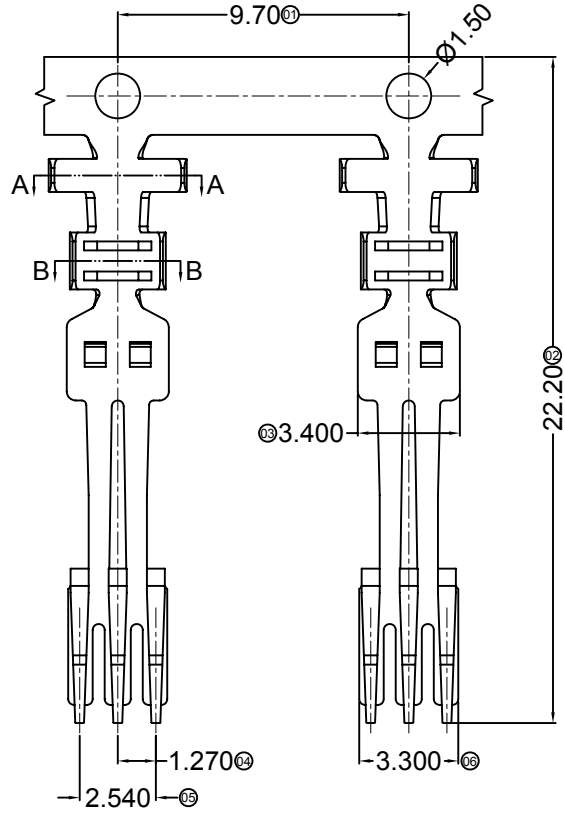

SECTION: A-A
SCALE: 1:1

SECTION: B-B
SCALE: 1:1

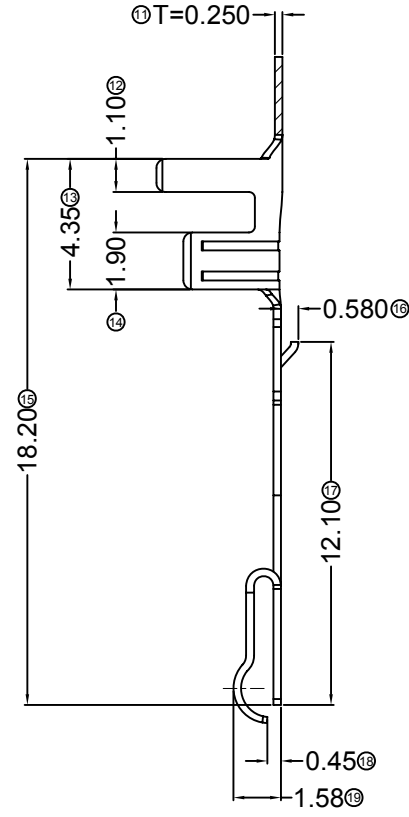

■ Specifications :

- Voltage rating: 15V AC / DC
- Current rating: 1.5A AC / DC
- Withstanding voltage: 500V AC/minute
- Temperature range: -35°C~+85°C
- Insulation resistance: ≥1000MΩ
- Contact resistance: ≤30mΩ
- After environmental testing: ≤60mΩ

1272 T H-P XXX X - X
① ② ③ ④ ⑤ ⑥ ⑦

- ① Series Number
- ② Category: T-terminal
- ③ Shape: H-High Crimp
- ④ Material: P-Phosphor bronze
- ⑤ Plating style: G01-Gold Flash ; G03-Gold 3u"
- ⑥ Plating method: Blank-Stamping before plating
- ⑦ Mold No./Mark/Special No.

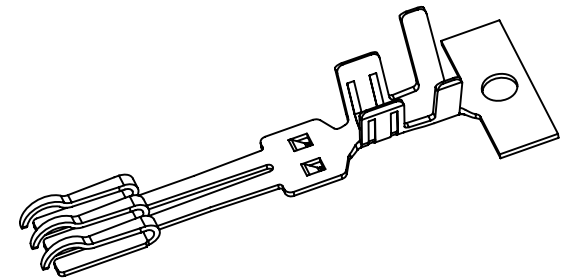

1272TH-PG03	Phosphor Bronze	AWG#20*2	Stamping Before plating:30u" MIN. Ni; Contact Area Gold:3u" Min.	1272H
1272TH-PG01			Stamping Before plating:30u" MIN. Ni; Contact Area Gold:Flash	
PART NO	Material	Wire Range	Finish	Used In SWB Housing

DATE	OLD REV	NEW REV	ECN	DESCRIPTION	CHECK	APPROVAL
1						
2						
3						
4						

GENERAL TOLERANCE
.X ±0.30
.XX ±0.20
.XXX ±0.10

SWB 思索连接器有限公司
TERMINAL&CONNECTORS SWB CONNECTORS CO.,LTD

APPROVAL	CHECK	DRAWN	DATA
Jova Lau	Wuxiaotao	X.W.X	2013/08/26

PART NO. 1272TH-PXXX			
TITLE 1.27mm Crimp Style Connectors			
UNIT MM	SCALE 1:1	NUMBER A-087	REV A

1 2 3 4 5 6 7 8

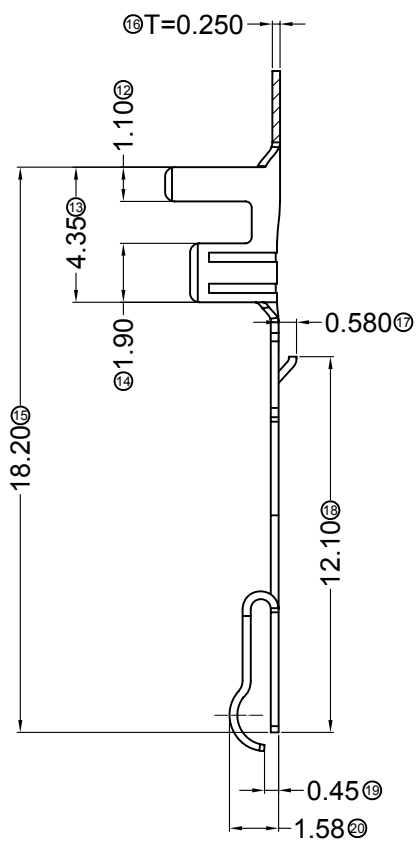
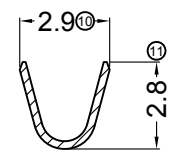
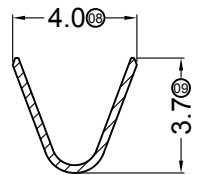
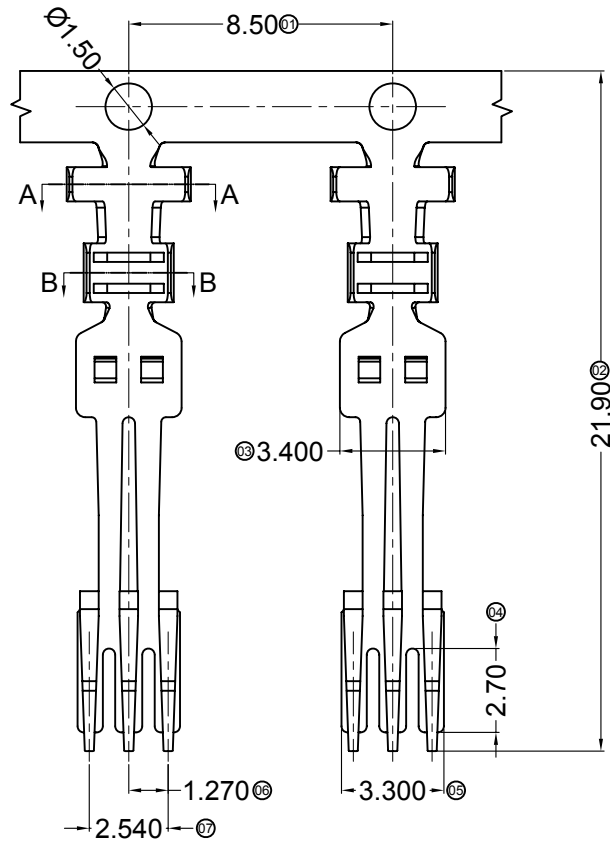

■ Specifications :



- Voltage rating: 15V AC / DC
- Current rating: 1.5A AC / DC
- Withstanding voltage: 500V AC/minute
- Temperature range: -35°C~+85°C
- Insulation resistance: ≥1000MΩ
- Contact resistance: ≤30mΩ
- After environmental testing: ≤60mΩ

1272 T L-P XXX X - X
 ① ② ③ ④ ⑤ ⑥ ⑦

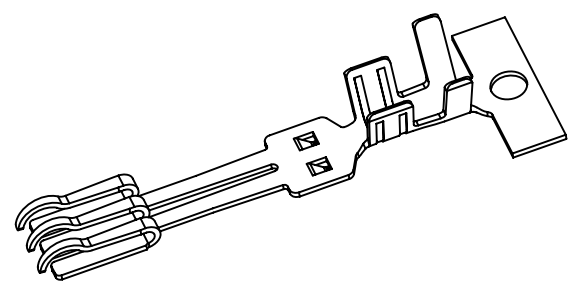
- ① Series Number
- ② Category: T-terminal
- ③ Shape: L-Lower Crimp
- ④ Material: P-Phosphor bronze
- ⑤ Plating style: G01-Gold Flash ; G03-Gold 3u"
- ⑥ Plating method: Blank-Stamping before plating
- ⑦ Mold No./Mark/Special No.



1272TL-PG03	Phosphor Bronze	AWG#18-22	1.10mm(Max)	Stamping Before plating:30u" MIN. Ni; Contact Area Gold:3u" Min.	1272H
1272TL-PG01				Stamping Before plating:30u" MIN. Ni; Contact Area Gold:Flash	
PART NO	Material	Wire Range	Insulation O.D.	Finish	Used In SWB Housing

							GENERAL TOLERANCE .X ±0.30 .XX ±0.20 .XXX ±0.10				 思索连接器有限公司 SWB CONNECTORS CO.,LTD				PART NO. 1272TL-PXXX TITLE 1.27mm Crimp Style Connectors			
2014/06/12	C	D		Modify the drawing frame format	Jova	Bob	APPROVAL	CHECK	DRAWN	DATA								
DATE	OLD REV	NEW REV	ECN	DESCRIPTION	CHECK	APPROVAL	PROJECT	Jova Lau	Wuxiaotao	Wuxiaotao	2014/06/12	UNIT	SCALE	NUMBER	REV			
												MM	1:1	A-087	D			