

■ Specifications :

- Voltage rating: 500V AC / DC
- Current rating: 2A AC / DC
- Withstanding voltage: 1500V AC/minute
- Temperature range: -40°C~+85°C
- Insulation resistance: ≥1000MΩ
- Contact resistance: ≤40mΩ
- After environmental testing: ≤80mΩ

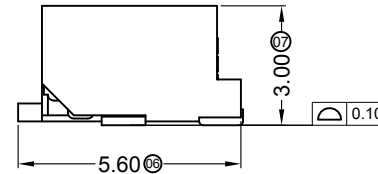
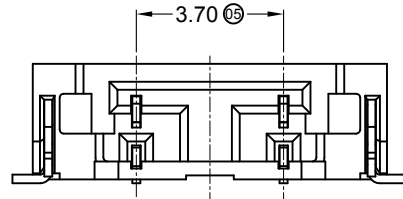

3700 W F X -02 X -LP XX XX  
 ① ② ③ ④ ⑤ ⑥ ⑦ ⑧ ⑨

- ① Series No
- ② Category: W-WAFER
- ③ Welding Board Angle: F-Female
- ④ Welding Way:
- ⑤ Row No.-Pin No.: XX-Single Row
- ⑥ Plug the Pin & Special No.
- ⑦ Material: LP -LCP 94V-0
- ⑧ Plating Category:  
SN-Bright Tin Plating ; SW- Matte Tin Plating
- ⑨ Color : Blank-Natural Color

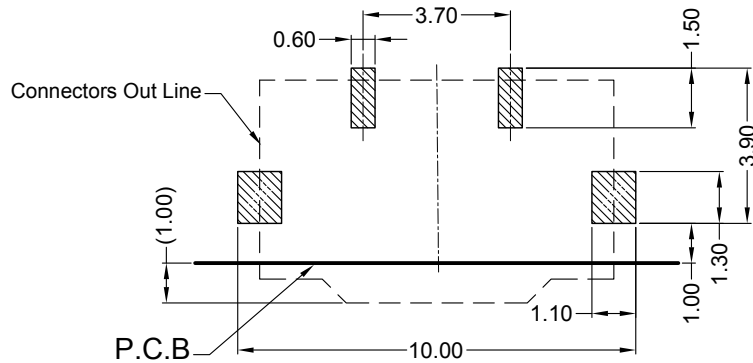

Recommended P.C.B Layout  
 General Tolerance±0.05

3700WF-02-LPSN	LCP UL 94V-0	Phosphor Bronze	Tin-Plated	Phosphor Bronze	Tin-Plated	3700WM
3700WF-02-LPSW	LCP UL 94V-0		Matte Tin-Plated		Matte Tin-Plated	
PART NO	Material	Material(Pin)	Finish(Pin)	Material (Solder Tab)	Finish (Solder Tab)	Mates With SWB Housing

DATE	OLD REV	NEW REV	ECN	DESCRIPTION	CHECK	APPROVAL

GENERAL TOLERANCE	.X ±0.30
	.XX ±0.20
	.XXX ±0.10
PROJECT	

 思索连接器有限公司 SWB CONNECTORS CO.,LTD			
APPROVAL	CHECK	DRAWN	DATA
Bob Sun	Jova Lau	Sylvia	2014/02/28

PART NO. 3700WF-02-LPXX			
TITLE 3.70mm BTB Style Connectors			
UNIT	SCALE	NUMBER	REV
MM	1 : 1	A-106	A

RoHS  Lead-free

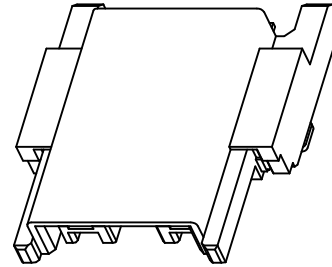
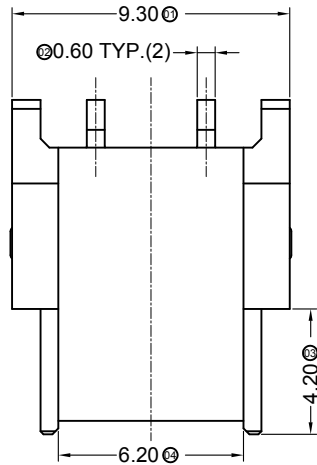

■ Specifications :

- Voltage rating: 500V AC / DC
- Current rating: 2A AC / DC
- Withstanding voltage: 1500V AC/minute
- Temperature range: -40°C~+85°C
- Insulation resistance: ≥1000MΩ
- Contact resistance: ≤40mΩ
- After environmental testing: ≤80mΩ

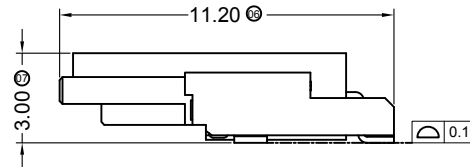
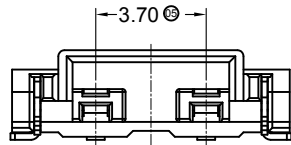

3700 W M X -02 X -LP XX XX  
 ① ② ③ ④ ⑤ ⑥ ⑦ ⑧ ⑨

- ① Series No
- ② Category: W-WAFER
- ③ Welding Board Angle: M-Male
- ④ Welding Way:
- ⑤ Row No.-Pin No.: 02-Single Row
- ⑥ Plug the Pin & Special No.
- ⑦ Material: LP -LCP 94V-0
- ⑧ Plating Category:  
SN-Bright Tin Plating ; SW- Matte Tin Plating
- ⑨ Color : Blank-Natural Color

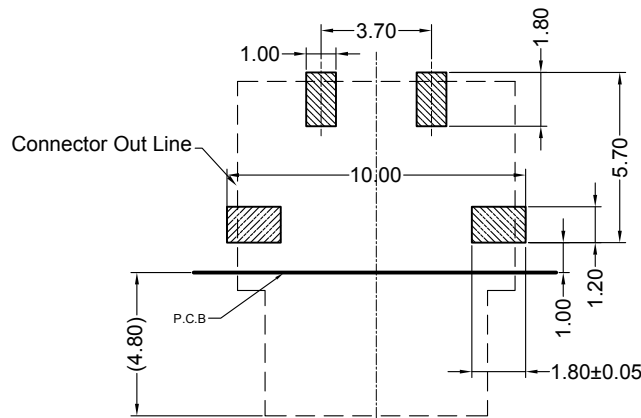

Recommended P.C.B Layout  
 General Tolerance±0.05

3700WM-02-LPSN	LCP UL 94V-0	Phosphor Bronze	Tin-Plated	Phosphor Bronze	Tin-Plated	3700WF
3700WM-02-LPSW	LCP UL 94V-0		Matte Tin-Plated	Matte Tin-Plated		
PART NO	Material	Material(Pin)	Finish(Pin)	Material (Solder Tab)	Finish (Solder Tab)	Mates With SWB Housing

							<b>GENERAL TOLERANCE</b> .X ±0.30 .XX ±0.20 .XXX ±0.10				 <b>思索连接器有限公司</b> <b>SWB CONNECTORS CO.,LTD</b>				<b>PART NO.</b> 3700WM-02-LPXX <b>TITLE</b> 3.70mm BTB Style Connectors			
							<b>APPROVAL</b> Bob Sun <b>CHECK</b> Jova Lau <b>DRAWN</b> Sylvia <b>DATA</b> 2014/02/28				<b>UNIT</b> MM <b>SCALE</b> 1 : 1 <b>NUMBER</b> A-106 <b>REV</b> A							
<b>DATE</b>	<b>OLD REV</b>	<b>NEW REV</b>	<b>ECN</b>	<b>DESCRIPTION</b>	<b>CHECK</b>	<b>APPROVAL</b>	<b>PROJECT</b>											