

■ Specifications :



- Voltage rating: 125V AC / DC
- Current rating: 3A AC / DC
- Withstanding voltage: 1000V AC/minute
- Temperature range: -40°C~+105°C
- Insulation resistance: ≥1000MΩ
- Contact resistance: ≤10mΩ
- After environmental testing: ≤20mΩ

2004 H X-XX X-N0 HF
① ②③ ④ ⑤ ⑥ ⑦

- ① Series No.
- ② Category: H-HSG
- ③ Appearance type: Blank-Ordinary
- ④ Row No.-Pin No.: XX-02P~15P
- ⑤ Plug the Pin & special No.: Blank-Ordinary
- ⑥ Material: N0-PA 66 94V-0
- ⑦ HF-Halogen Free

Poles	Dimensions (mm)			Poles	Dimensions (mm)		
	A	B	C		A	B	C
02	2.00	6.00	4.80	09	16.00	20.00	18.80
03	4.00	8.00	6.80	10	18.00	22.00	20.80
04	6.00	10.00	8.80	11	20.00	24.00	22.80
05	8.00	12.00	10.80	12	22.00	26.00	24.80
06	10.00	14.00	12.80	13	24.00	28.00	26.80
07	12.00	16.00	14.80	14	26.00	30.00	28.80
08	14.00	18.00	16.80	15	28.00	32.00	30.80

2004H-XX-N0HF	PA 66 UL 94V-0 Halogen Free	2004T	2004W
2004H-XX-N0	PA 66 UL 94V-0		
PART NO	Material	Suitable SWB Terminal	Mates With SWB Wafer

							GENERAL TOLERANCE .X ±0.30 .XX ±0.20 .XXX ±0.10	 思索连接器有限公司 SWB CONNECTORS CO.,LTD				PART NO. 2004H-XX-N0HF			
Space of a Whole page Changes							PROJECT 					APPROVAL	CHECK	DRAWN	DATA
DATE	OLD REV	NEW REV	ECN	DESCRIPTION	CHECK	APPROVAL	Jova Lau	W.X.T	Wuxiaotao	2014/07/15	UNIT MM	SCALE 1:1	NUMBER A-022	REV D	

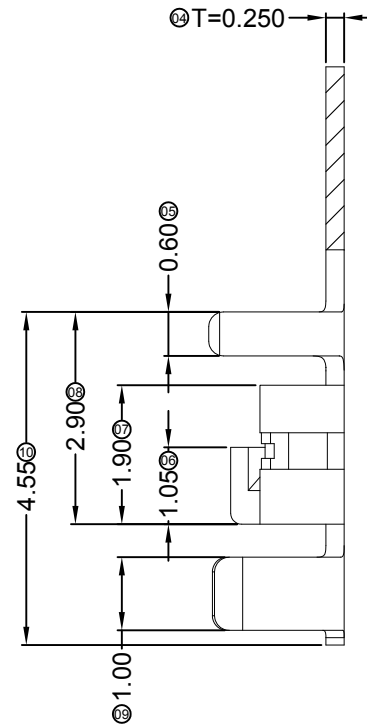
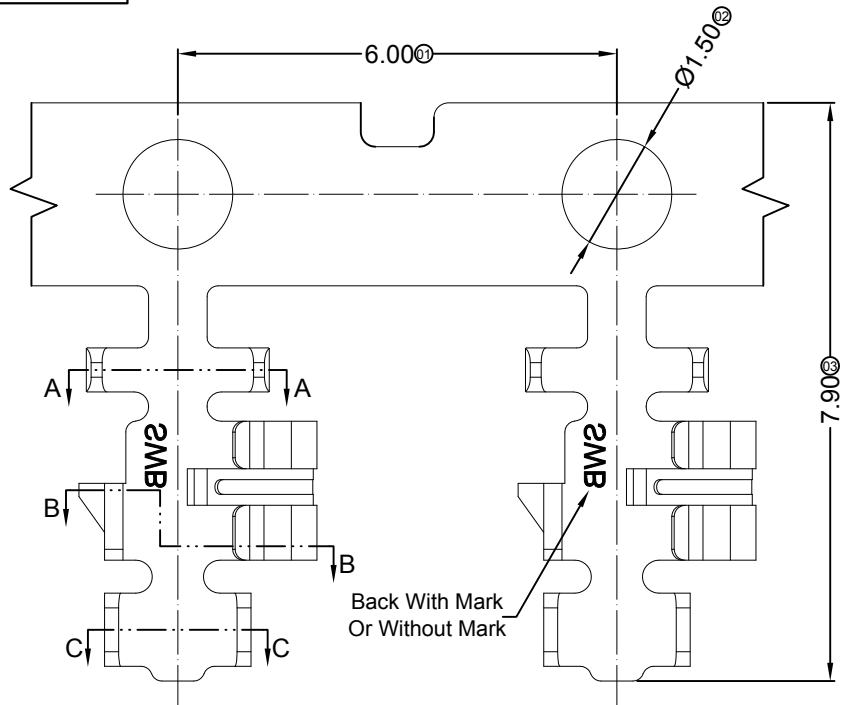

■ Specifications :

- Voltage rating: 125V AC / DC
- Current rating: 3A AC / DC
- Withstanding voltage: 1000V AC/minute
- Temperature range: -40°C~+105°C
- Insulation resistance: ≥1000MΩ
- Contact resistance: ≤10mΩ
- After environmental testing: ≤20mΩ

2004 T X-P SN X- X
① ② ③ ④ ⑤ ⑥ ⑦

- ① Series Number
- ② Category: T-terminal
- ③ Shape: Blank-ordinary
- ④ Material: P-Phosphor bronze
- ⑤ Plating style: SN-Bright tin plating
- ⑥ Plating method: Blank-Stamping before plating
- ⑦ Mold No./Mark/Special No.: M-With "SWB" Mark

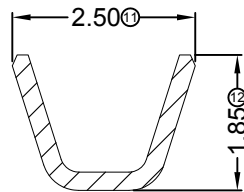

SECTION: A-A
SCALE: 1:1

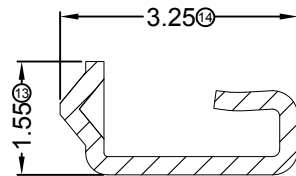

SECTION: B-B
SCALE: 1:1

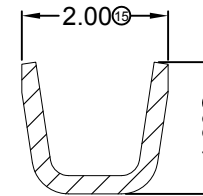

SECTION: C-C
SCALE: 1:1

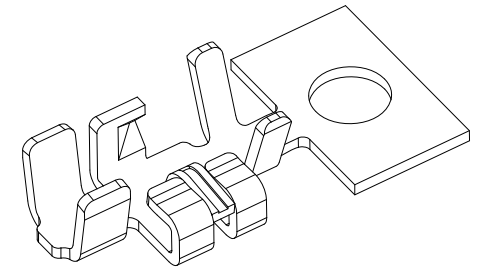

2004T-PSN-M	Phosphor Bronze	AWG#24-28	1.05mm(Max)	Stamping Before Plating:30u" Ni;70u"Sn	2004H
2004T-PSN	Phosphor Bronze	AWG#24-28	1.05mm(Max)	Stamping Before Plating:30u" Ni;70u"Sn	
PART NO	Material	Wire Range	Insulation O.D.	Finish	Used In SWB Housing

2014/07/24	C	D		Modify the drawing frame format	Wuxiaotao	Jova
DATE	OLD REV	NEW REV	ECN	DESCRIPTION	CHECK	APPROVAL

GENERAL TOLERANCE
.X ±0.30
.XX ±0.20
.XXX ±0.10



SWB 思索连接器有限公司
TERMINAL&CONNECTORS SWB CONNECTORS CO.,LTD

APPROVAL	CHECK	DRAWN	DATA
Jova Lau	W.X.T	Wuxiaotao	2014/07/24

PART NO. 2004T-PSN			
TITLE 2.00mm Crimp Style Connectors			
UNIT	SCALE	NUMBER	REV
MM	1:1	A-106	D

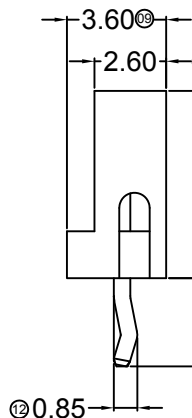
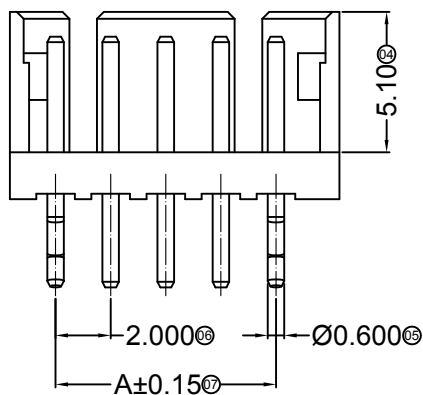
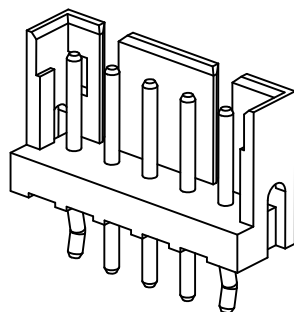
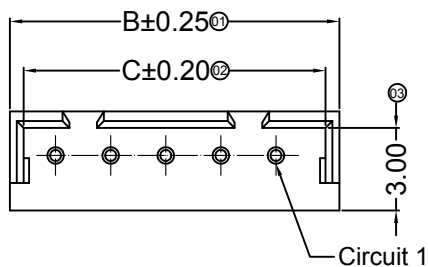

■ Specifications :

- Voltage rating: 125V AC / DC
- Current rating: 3A AC / DC
- Withstanding voltage: 1000V AC/minute
- Temperature range: -40°C~+105°C
- Insulation resistance: ≥1000MΩ
- Contact resistance: ≤10mΩ
- After environmental testing: ≤20mΩ

2004 W V X-XX X -N0 SN XX
 ① ② ③ ④ ⑤ ⑥ ⑦ ⑧ ⑨

- ① Series No.
- ② Category: W-WAFER
- ③ Welding Board Angle: V-Straight 180°
- ④ Welding Way: Blank-DIP
- ⑤ Row No.-Pin No.: XX-02P~15P
- ⑥ Plug the Pin & Special No.: Blank-With Kink ;
- ⑦ Material: N0-PA66 94V-0
- ⑧ Plating Category: SN-Bright Tin Plating (70u" Min.)
- ⑨ Color : Blank-Natural Color

02P~15P Double Gap
Scale 1:1

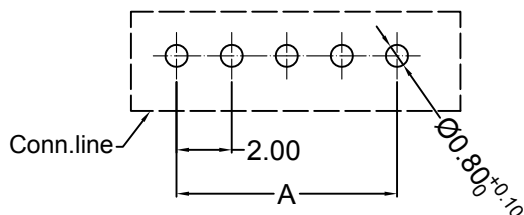

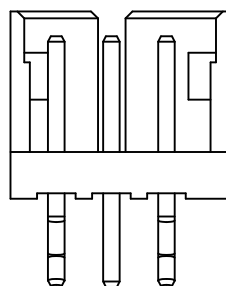

Recommended P.C.B Layout
General Tolerance±0.05



02P~03P Single Gap
Scale 1:1

Poles	Dimensions (mm)			Poles	Dimensions (mm)		
	A	B	C		A	B	C
02	2.00	5.96	4.96	09	16.00	19.96	18.96
03	4.00	7.96	6.96	10	18.00	21.96	20.96
04	6.00	9.96	8.96	11	20.00	23.96	22.96
05	8.00	11.96	10.96	12	22.00	25.96	24.96
06	10.00	13.96	12.96	13	24.00	27.96	26.96
07	12.00	15.96	14.96	14	26.00	29.96	28.96
08	14.00	17.96	16.96	15	28.00	31.96	30.96

2004WV-XX-N0SN	PA 66 UL 94V-0	Brass	Tin-Plated	2004H
PART NO	Material	Material(Pin)	Finish(Pin)	Mates With SWB Housing

							GENERAL TOLERANCE		 思索连接器有限公司 SWB CONNECTORS CO.,LTD				PART NO. 2004WV-XX-N0SN			
							.X ±0.30 .XX ±0.20 .XXX ±0.10						TITLE 2.00mm Crimp Style Connectors			
2014/07/22	E	F		Modify the drawing frame format	Wuxiaotao	Jova	PROJECT		APPROVAL	CHECK	DRAWN	DATA	UNIT	SCALE	NUMBER	REV
DATE	OLD REV	NEW REV	ECN	DESCRIPTION	CHECK	APPROVAL			Jova Lau	W.X.T	Wuxiaotao	2014/07/22	MM	1:1	A-106	F

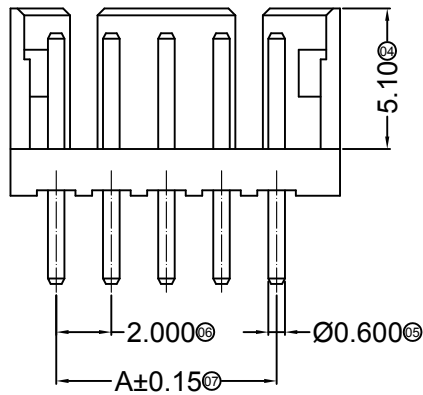
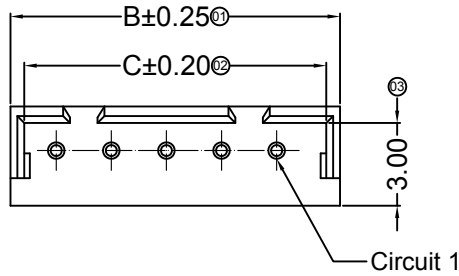

02P~15P Double Gap
Scale 1:1

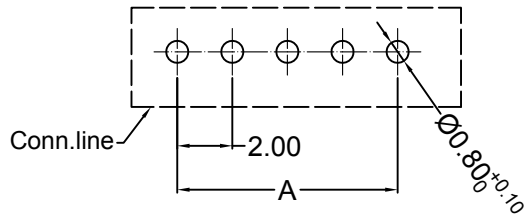

Recommended P.C.B Layout
General Tolerance±0.05

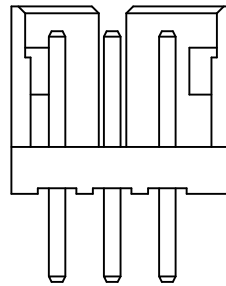
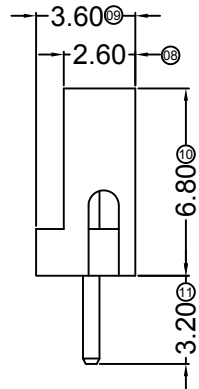
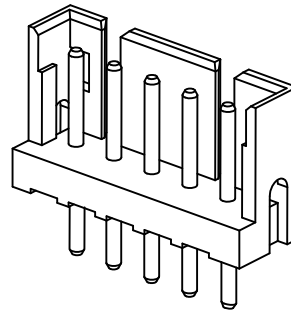

02P~03P Single Gap
Scale 1:1

■ Specifications :

- Voltage rating: 125V AC / DC
- Current rating: 3A AC / DC
- Withstanding voltage: 1000V AC/minute
- Temperature range: -40°C~+105°C
- Insulation resistance: ≥1000MΩ
- Contact resistance: ≤10mΩ
- After environmental testing: ≤20mΩ

2004 W V X-XX NK -N0 SN XX
① ② ③ ④ ⑤ ⑥ ⑦ ⑧ ⑨

- ① Series No.
- ② Category: W-WAFER
- ③ Welding Board Angle: V-Straight 180°
- ④ Welding Way: Blank-DIP
- ⑤ Row No.-Pin No.: XX-02P~15P
- ⑥ Plug the Pin & Special No.: NK-Without Kink
- ⑦ Material: N0-PA66 94V-0
- ⑧ Plating Category: SN-Bright Tin Plating (70u" Min.)
- ⑨ Color: Blank-Natural Color

Poles	Dimensions (mm)			Poles	Dimensions (mm)		
	A	B	C		A	B	C
02	2.00	5.96	4.96	09	16.00	19.96	18.96
03	4.00	7.96	6.96	10	18.00	21.96	20.96
04	6.00	9.96	8.96	11	20.00	23.96	22.96
05	8.00	11.96	10.96	12	22.00	25.96	24.96
06	10.00	13.96	12.96	13	24.00	27.96	26.96
07	12.00	15.96	14.96	14	26.00	29.96	28.96
08	14.00	17.96	16.96	15	28.00	31.96	30.96

2004WV-XXNK-N0SN	PA 66 UL 94V-0	Brass	Tin-Plated	2004H
PART NO	Material	Material(Pin)	Finish(Pin)	Mates With SWB Housing

							GENERAL TOLERANCE .X ±0.30 .XX ±0.20 .XXX ±0.10				SWB 思索连接器有限公司 TERMINAL&CONNECTORS SWB CONNECTORS CO.,LTD				PART NO. 2004WV-XXNK-N0SN			
							APPROVAL CHECK DRAWN DATA				TITLE 2.00mm Crimp Style Connectors							
2014/07/22	E	F	Modify the drawing frame format			Wuxiaotao	Jova	Jova Lau	W.X.T	Wuxiaotao	2014/07/22	UNIT	SCALE	NUMBER	REV			
DATE	OLD REV	NEW REV	ECN	DESCRIPTION			CHECK	APPROVAL				MM	1:1	A-106	F			

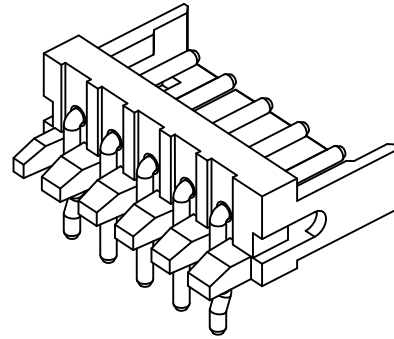
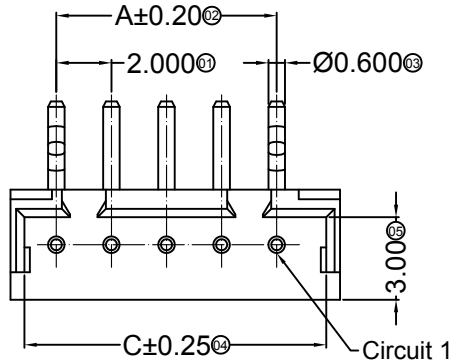

■ Specifications :

- Voltage rating: 125V AC / DC
- Current rating: 3A AC / DC
- Withstanding voltage: 1000V AC/minute
- Temperature range: -40°C~+105°C
- Insulation resistance: ≥1000MΩ
- Contact resistance: ≤10mΩ
- After environmental testing: ≤20mΩ

2004 W R X-XX X -N0 SN XX
 ① ② ③ ④ ⑤ ⑥ ⑦ ⑧ ⑨

- ① Series No.
- ② Category: W-WAFER
- ③ Welding Board Angle: R-Right Angle 90°
- ④ Welding Way: Blank-DIP
- ⑤ Row No.-Pin No.: XX-02P~15P
- ⑥ Plug the Pin & Special No.:
- ⑦ Material: N0-PA66 94V-0
- ⑧ Plating Category: SN-Bright Tin Plating (70u" Min.)
SN2-Bright Tin Plating (120u" Min.)
- ⑨ Color : Blank-Natural Color

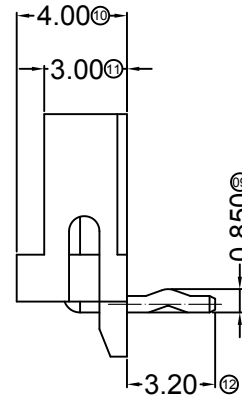
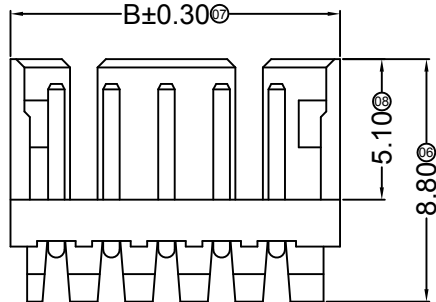

02P~15P Double Gap
Scale 1:1

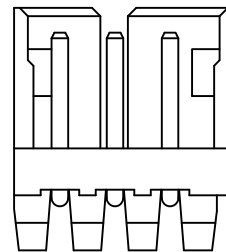

02P~03P Single Gap
Scale 1:1

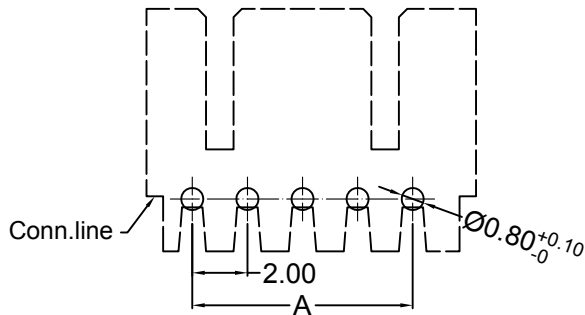

Recommended P.C.B Layout
General Tolerance±0.05

Poles	Dimensions (mm)			Poles	Dimensions (mm)		
	A	B	C		A	B	C
02	2.00	5.96	4.96	09	16.00	19.96	18.96
03	4.00	7.96	6.96	10	18.00	21.96	20.96
04	6.00	9.96	8.96	11	20.00	23.96	22.96
05	8.00	11.96	10.96	12	22.00	25.96	24.96
06	10.00	13.96	12.96	13	24.00	27.96	26.96
07	12.00	15.96	14.96	14	26.00	29.96	28.96
08	14.00	17.96	16.96	15	28.00	31.96	30.96

2004WR-XX-N0SN	PA 66 UL 94V-0	Brass	Tin-Plated	2004H
2004WR-XX-N0SN2			Sn 120u"Min.	
PART NO	Material	Material(Pin)	Finish(Pin)	Mates With SWB Housing

				GENERAL TOLERANCE		SWB 思索连接器有限公司 TERMINAL&CONNECTORS SWB CONNECTORS CO.,LTD				PART NO. 2004WR-XX-N0SNX			
				.X ±0.30					TITLE 2.00mm Crimp Style Connectors				
				.XX ±0.20	APPROVAL				CHECK				
				.XXX ±0.10	DRAWN				DATA				
2014/07/16	C	D	Modify the drawing frame format	Wuxiaotao	Jova	Jova Lau	W.X.T	Wuxiaotao	2014/07/16	UNIT MM	SCALE 1:1	NUMBER A-106	REV D
DATE	OLD REV	NEW REV	ECN	DESCRIPTION	CHECK	APPROVAL	PROJECT						